

## The RF Sub-Micron MOSFET Line

# RF Power Field Effect Transistors

## N-Channel Enhancement-Mode Lateral MOSFETs

Designed for PCN and PCS base station applications at frequencies from 1000 to 2400 MHz. Suitable for FM, TDMA, CDMA, and multicarrier amplifier applications. To be used in class A and class AB for PCN-PCS/cellular radio and WLL applications.

- Specified Two-Tone Performance @ 2000 MHz, 26 Volts
  - Output Power — 60 Watts (PEP)
  - Power Gain — 9.5 dB
  - Intermodulation Distortion — -28 dBc
- Typical Two-Tone Performance at 2000 MHz, 26 Volts
  - Output Power — 60 Watts (PEP)
  - Power Gain — 10.5 dB
  - Efficiency — 32%
  - Intermodulation Distortion — -30 dBc
- S-Parameter Characterization at High Bias Levels
- Capable of Handling 10:1 VSWR, @ 26 Vdc, 2000 MHz, 60 Watts (CW) Output Power
- Excellent Thermal Stability
- Characterized with Series Equivalent Large-Signal Impedance Parameters

### MRF286 MRF286S

Order sample parts by XRF286,S  
PILOT PRODUCTION PROTOTYPE

2000 MHz, 60 W, 26 V  
LATERAL N-CHANNEL  
BROADBAND  
RF POWER MOSFETs

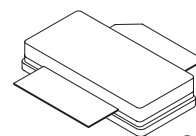
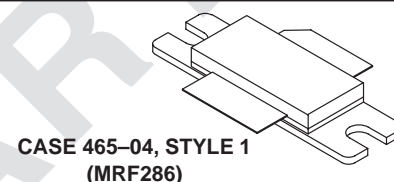

#### MAXIMUM RATINGS

Rating	Symbol	Value	Unit
Drain-Source Voltage	$V_{DSS}$	65	Vdc
Gate-Source Voltage	$V_{GS}$	$\pm 20$	Vdc
Total Device Dissipation @ $T_C = 25^\circ\text{C}$ Derate above $25^\circ\text{C}$	$P_D$	240 1.37	Watts W/ $^\circ\text{C}$
Storage Temperature Range	$T_{stg}$	-65 to +150	$^\circ\text{C}$
Operating Junction Temperature	$T_J$	200	$^\circ\text{C}$

#### THERMAL CHARACTERISTICS

Characteristic	Symbol	Max	Unit
Thermal Resistance, Junction to Case	$R_{\theta JC}$	0.73	$^\circ\text{C}/\text{W}$

NOTE – **CAUTION** – MOS devices are susceptible to damage from electrostatic charge. Reasonable precautions in handling and packaging MOS devices should be observed.

“PILOT PRODUCTION PROTOTYPE (“X” Status)” devices are preproduction products and may not be released or produced in volume. “X” status devices are for engineering evaluation and should not be used for production. Specifications are subject to change without notice.



**ELECTRICAL CHARACTERISTICS** ( $T_C = 25^\circ\text{C}$  unless otherwise noted)

Characteristic	Symbol	Min	Typ	Max	Unit
<b>OFF CHARACTERISTICS</b>					
Drain–Source Breakdown Voltage ( $V_{GS} = 0, I_D = 20 \mu\text{Adc}$ )	$V_{(BR)DSS}$	65	—	—	Vdc
Gate–Source Leakage Current ( $V_{GS} = 20 \text{ Vdc}, V_{DS} = 0 \text{ Vdc}$ )	$I_{GSS}$	—	—	1	$\mu\text{Adc}$
Zero Gate Voltage Drain Leakage Current ( $V_{DS} = 28 \text{ Vdc}, V_{GS} = 0$ )	$I_{DSS}$	—	—	10	$\mu\text{Adc}$
<b>ON CHARACTERISTICS</b>					
Forward Transconductance ( $V_{DS} = 10 \text{ Vdc}, I_D = 2 \text{ Adc}$ )	$g_{fs}$	—	3	—	S
Gate Threshold Voltage ( $V_{DS} = 10 \text{ V}, I_D = 300 \mu\text{A}$ )	$V_{GS(th)}$	2	3.2	4	Vdc
Gate Quiescent Voltage ( $V_{DS} = 26 \text{ V}, I_D = 500 \text{ mA}$ )	$V_{GS(Q)}$	3	4.15	5	Vdc
Drain–Source On–Voltage ( $V_{GS} = 10 \text{ V}, I_D = 1 \text{ A}$ )	$V_{DS(on)}$	—	0.16	0.6	Vdc
<b>DYNAMIC CHARACTERISTICS</b>					
Reverse Transfer Capacitance ( $V_{DS} = 26 \text{ Vdc}, V_{GS} = 0, f = 1 \text{ MHz}$ )	$C_{rss}$	—	3	—	pF
Input Capacitance <sup>(1)</sup> ( $V_{DS} = 26 \text{ Vdc}, V_{GS} = 0, f = 1 \text{ MHz}$ )	$C_{iss}$	—	145	—	pF
Output Capacitance ( $V_{DS} = 26 \text{ Vdc}, V_{GS} = 0, f = 1 \text{ MHz}$ )	$C_{oss}$	—	51	—	pF
<b>FUNCTIONAL TESTS</b> (In Motorola Test Fixture)					
Common–Source Amplifier Power Gain ( $V_{DD} = 26 \text{ Vdc}, P_{out} = 60 \text{ W PEP}, I_{DQ} = 500 \text{ mA}, f_1 = 2000.0 \text{ MHz}, f_2 = 2000.1 \text{ MHz}$ )	$G_{ps}$	9.5	10.5	—	dB
Drain Efficiency ( $V_{DD} = 26 \text{ Vdc}, P_{out} = 60 \text{ W PEP}, I_{DQ} = 500 \text{ mA}, f_1 = 2000.0 \text{ MHz}, f_2 = 2000.1 \text{ MHz}$ )	$\eta$	28	32	—	%
Intermodulation Distortion ( $V_{DD} = 26 \text{ Vdc}, P_{out} = 60 \text{ W PEP}, I_{DQ} = 500 \text{ mA}, f_1 = 2000.0 \text{ MHz}, f_2 = 2000.1 \text{ MHz}$ )	IMD	—	30	–28	dBc
Input Return Loss ( $V_{DD} = 26 \text{ Vdc}, P_{out} = 60 \text{ W PEP}, I_{DQ} = 500 \text{ mA}, f_1 = 2000.0 \text{ MHz}, f_2 = 2000.1 \text{ MHz}$ )	IRL	—	–12	–9	dB
Output Mismatch Stress ( $V_{DD} = 26 \text{ Vdc}, P_{out} = 60 \text{ W CW}, I_{DQ} = 500 \text{ mA}, f = 2 \text{ GHz}, \text{VSWR} = 10:1, \text{All Phase Angles at Frequency of Tests}$ )	$\Psi$	No Degradation In Output Power			

(1) Part is internally matched both on input and output.

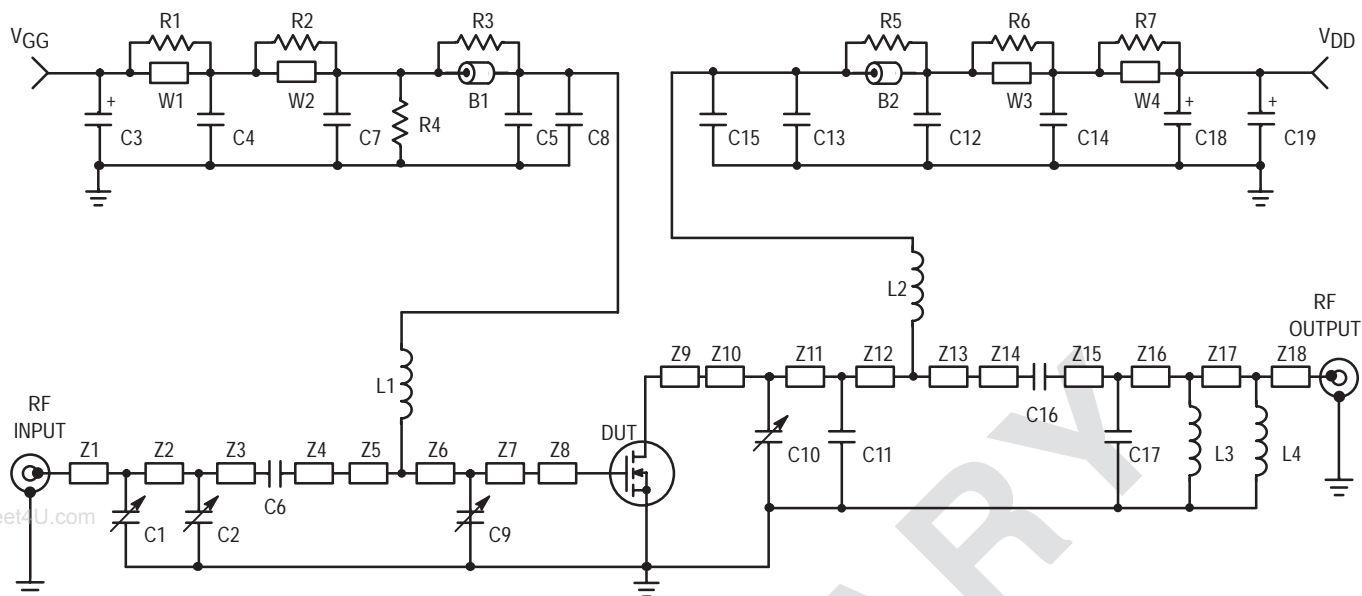

Z1	0.436" x 0.080" Microstrip	Z13	0.025" x 0.325" Microstrip
Z2	0.248" x 0.080" Microstrip	Z14	0.544" x 0.080" Microstrip
Z3	0.610" x 0.080" Microstrip	Z15	0.108" x 0.080" Microstrip
Z4	0.529" x 0.080" Microstrip	Z16	0.095" x 0.080" Microstrip
Z5	0.024" x 0.325" Microstrip	Z17	0.996" x 0.080" Microstrip
Z6	0.144" x 0.325" Microstrip	Z18	0.077" x 0.080" Microstrip
Z7	0.098" x 0.325" Microstrip	Board	0.030" Glass Teflon®, 2 oz Copper, 3" x 5" Dimensions, Arlon GX0300-55-22, $\epsilon_r = 2.55$
Z8	0.215" x 0.515" Microstrip	RF Circuit Board	3" x 5" Copper Clad PCB, Glass Teflon®, $\epsilon_r = 2.55$
Z9	0.215" x 0.515" Microstrip		
Z10	0.044" x 0.325" Microstrip		
Z11	0.060" x 0.325" Microstrip		
Z12	0.141" x 0.325" Microstrip		

Figure 1. 1.93 – 2.0 GHz Broadband Test Circuit Schematic

Table 1. 1.93 – 2.0 GHz Broadband Component Designations and Values

Designators	Description
B1, B2	Ferrite Bead, Round, Newark #95F769
C1, C2, C9	0.8–8.0 pF, Variable Capacitors, Gigatrim Johanson, Newark #44F3360
C3, C18	22 $\mu$ F, 35 V Tantalum Surface Mount Chip Capacitors, Kemet #T491X226K035AS4394
C4, C14	0.1 $\mu$ F, Chip Capacitors, Kemet #CDR33BX104AKWS
C5, C15	91 pF, RF Chip Capacitors, B Case, ATC #100B910JP500X
C6	8.2 pF, RF Chip Capacitor, B Case, ATC #100B8R2CP500X
C7, C12	1000 pF, RF Chip Capacitors, B Case, ATC #100B102JP50X
C8, C13	5.1 pF, RF Chip Capacitors, B Case, ATC #100B5R1CP500X
C10	0.4–2.5 pF, Variable Capacitor, Gigatrim Johanson, Newark #44F3367
C11	2.2 pF, RF Chip Capacitor, B Case, ATC #100B2R2JP500X
C16	200 pF, RF Chip Capacitor, B Case, ATC #100B201JP500X
C17	0.1 pF, RF Chip Capacitor, B Case, ATC #100B0R1BP500X
C19	10 $\mu$ F, 35 V Tantalum Surface Mount Chip Capacitor, Kemet #T495X106K035AS4394
L1	8 Turns, #24 AWG, 0.120" OD, 0.270" Long (28.0 nH), CoilCraft #B08T-5
L2	6 Turns, #24 AWG, 0.195" OD, 0.150" Long (47.0 nH), CoilCraft #1812SMS-47NJ
L3	2 Turns, #24 AWG, 0.120" OD, 0.145" Long (5.0 nH), CoilCraft #A02T-5
L4	3 Turns, #24 AWG, 0.120" OD, 0.145" Long (8.0 nH), CoilCraft #A03T-5
R1, R2, R3, R5, R6, R7	12 $\Omega$ , 1/4 W Chip Resistors (0.08" x 0.13"), Garrett Instruments #RM73B2B120JT
R4	560 k $\Omega$ , 1/4 W Chip Resistor (0.08" x 0.13")
W1, W2, W3, W4	Solid Copper Buss Wire, #16 AWG
WS1, WS2	Beryllium Copper Wear Blocks (0.005" x 0.210" x 0.520") Nominal

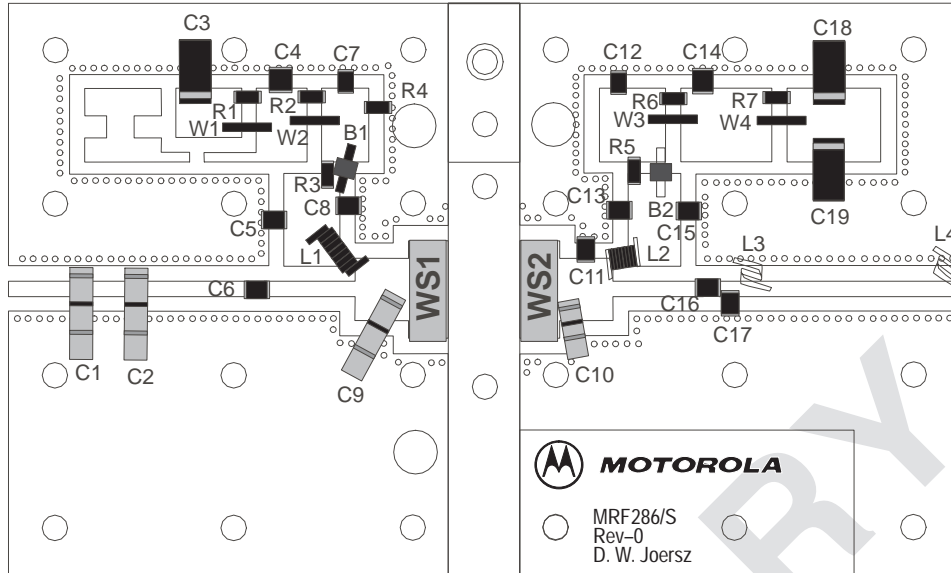
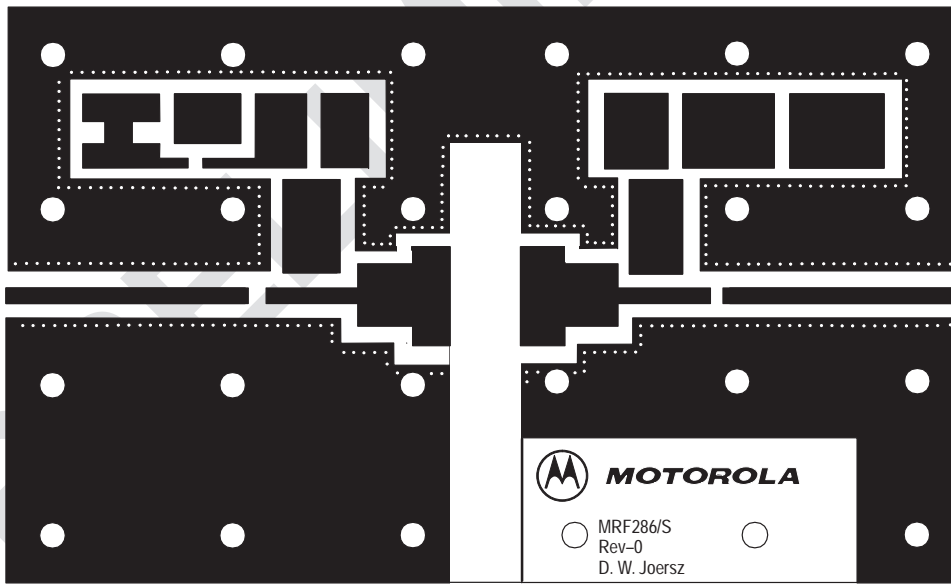
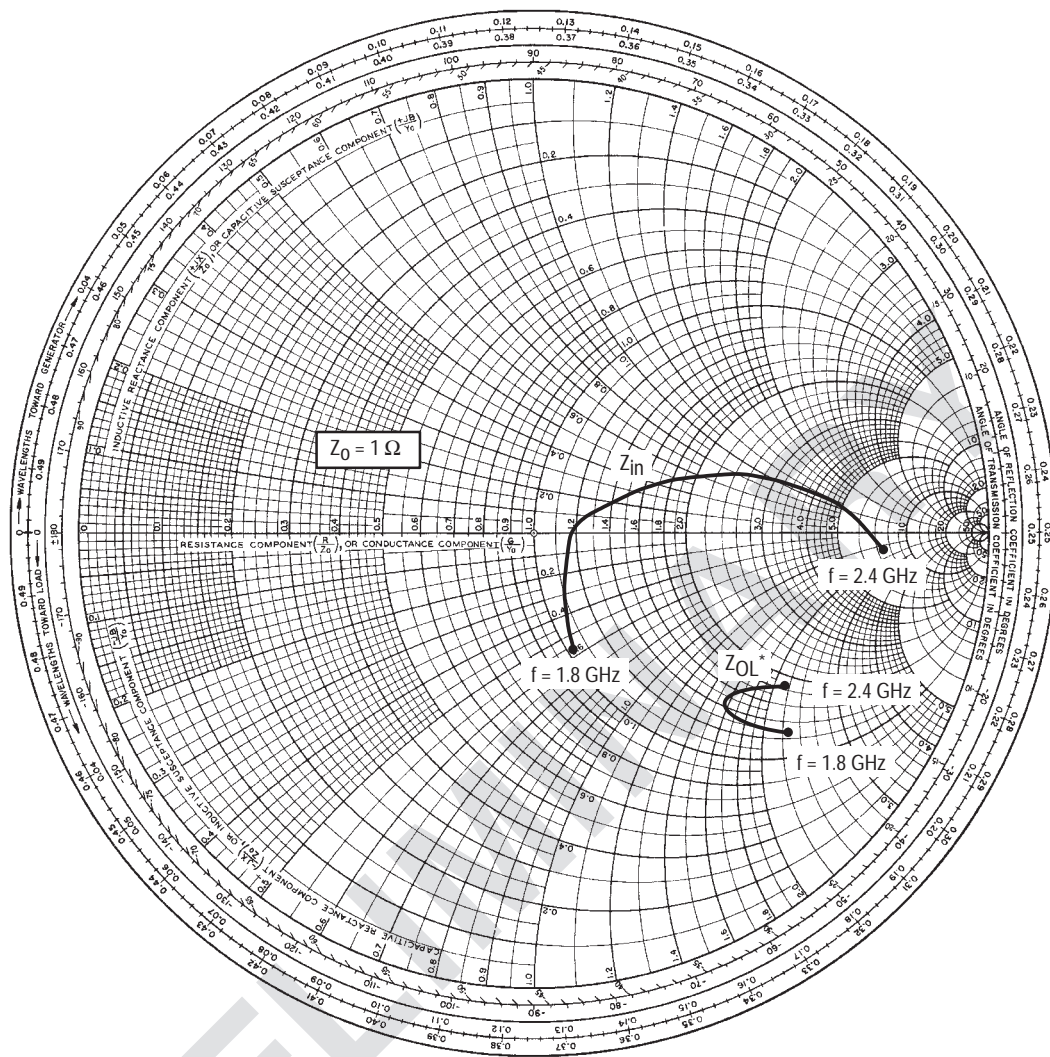

Figure 2. 1.93–2.0 GHz Broadband Test Circuit Component Layout



(Scale 1:1)

Figure 3. MRF286 Test Circuit Photomaster  
(Reduced 18% in printed data book, DL110/D)



$V_{DD} = 26\text{ V}$ ,  $I_{DQ} = 500\text{ mA}$ ,  $P_{out} = 60\text{ Watts (PEP)}$

f MHz	$Z_{in}$ $\Omega$	$Z_{OL}^*$ $\Omega$
1800	$1.0 - j0.57$	$1.25 - j2.31$
1900	$1.19 - j0.005$	$1.35 - j2.0$
2000	$1.38 + j0.20$	$1.40 - j1.6$
2100	$1.75 + j0.47$	$1.60 - j1.7$
2200	$2.40 + j0.80$	$1.80 - j2.0$
2300	$4.90 + j1.20$	$1.85 - j2.1$
2400	$7.50 - j1.85$	$1.90 - j2.18$

$Z_{in}$  = Complex conjugate of source impedance.

$Z_{OL}^*$  = Complex conjugate of the optimum load impedance at given output power, voltage, IMD, bias current and frequency.

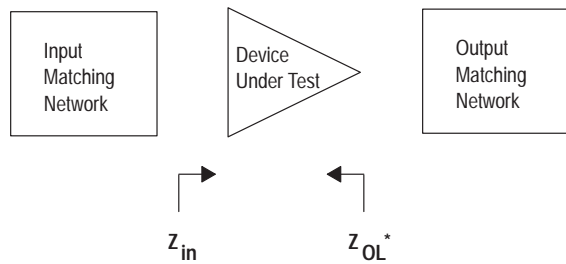

**Figure 4. Series Large-Signal Device Impedances**

Table 2. High Bias Small-Signal S-Parameters

$I_D = 3.6 \text{ A}$

f GHz	S <sub>11</sub>		S <sub>21</sub>		S <sub>12</sub>		S <sub>22</sub>	
	S <sub>11</sub>	φ	S <sub>21</sub>	φ	S <sub>12</sub>	φ	S <sub>22</sub>	φ
1.0	0.945	-180	0.458	8	0.02	105	0.905	-179
1.1	0.949	-180	0.406	5	0.02	93	0.900	-180
1.2	0.954	178	0.357	1	0.03	79	0.885	180
1.3	0.961	178	0.324	-1	0.03	73	0.874	-179
1.4	0.957	177	0.301	-3	0.03	74	0.889	-178
1.5	0.953	176	0.290	-6	0.02	59	0.899	-178
1.6	0.950	175	0.275	-9	0.02	75	0.921	-178
1.7	0.946	175	0.271	-12	0.02	79	0.927	-180
1.8	0.942	174	0.275	-16	0.03	80	0.934	180
1.9	0.936	174	0.286	-21	0.03	81	0.939	179
2.0	0.945	173	0.310	-27	0.03	83	0.943	177
2.1	0.952	171	0.354	-36	0.03	75	0.940	177
2.2	0.954	170	0.427	-51	0.04	81	0.944	176
2.3	0.915	167	0.513	-76	0.04	71	0.957	175
2.4	0.851	169	0.507	-112	0.04	72	0.970	174
2.5	0.916	172	0.417	-148	0.05	88	0.983	172
2.6	0.936	169	0.260	-180	0.08	66	0.977	170
2.7	0.953	168	0.172	164	0.08	54	0.980	170

## PACKAGE DIMENSIONS

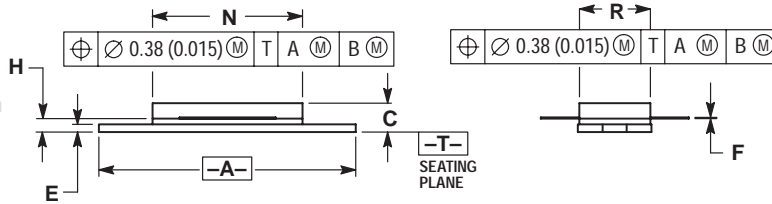
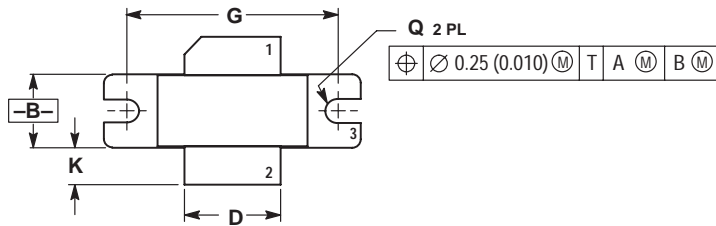

**NOTES:**

1. DIMENSIONING AND TOLERANCING PER ANSI Y14.5M, 1982.
2. CONTROLLING DIMENSION: INCH.
3. 465-01, -02 AND -03 OBSOLETE, NEW STANDARD 465-04.
4. DIMENSION H IS MEASURED 0.030" AWAY FROM FLANGE.

DIM	INCHES		MILLIMETERS	
	MIN	MAX	MIN	MAX
A	1.335	1.345	33.91	34.16
B	0.380	0.390	9.65	9.91
C	0.125	0.170	3.18	4.32
D	0.495	0.505	12.57	12.83
E	0.035	0.045	0.89	1.14
F	0.003	0.006	0.08	0.15
G	1.100 BSC		27.94 BSC	
H	0.055	0.065	1.40	1.65
K	0.170	0.210	4.32	5.33
N	0.772	0.788	19.60	20.00
Q	0.118	0.138	3.00	3.51
R	0.365	0.375	9.27	9.53

**STYLE 1:**

- PIN 1. DRAIN
2. GATE
3. SOURCE

**CASE 465-04  
ISSUE D  
(MRF286)**

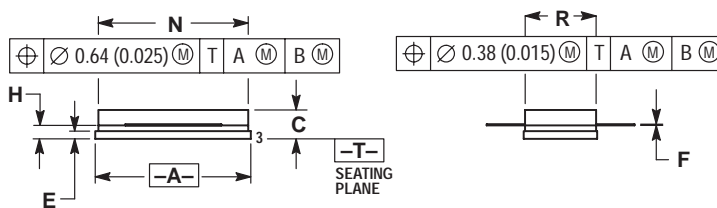
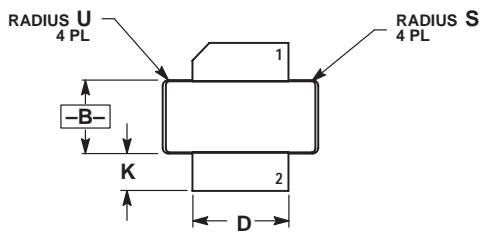

**NOTES:**

1. DIMENSIONING AND TOLERANCING PER ANSI Y14.5M, 1982.
2. CONTROLLING DIMENSION: INCH.
3. DIMENSION H IS MEASURED 0.030" AWAY FROM FLANGE.

DIM	INCHES		MILLIMETERS	
	MIN	MAX	MIN	MAX
A	0.805	0.815	20.45	20.70
B	0.380	0.390	9.65	9.91
C	0.125	0.170	3.18	4.32
D	0.495	0.505	12.57	12.83
E	0.035	0.045	0.89	1.14
F	0.003	0.006	0.08	0.15
H	0.055	0.065	1.40	1.65
K	0.170	0.210	4.32	5.33
N	0.775	0.785	19.69	19.94
R	0.365	0.375	9.27	9.53
S	0.020 REF		0.51 REF	
U	0.030 REF		0.76 REF	

**STYLE 1:**

- PIN 1. DRAIN
2. GATE
4. SOURCE

**CASE 465A-04  
ISSUE D  
(MRF286S)**

Motorola reserves the right to make changes without further notice to any products herein. Motorola makes no warranty, representation or guarantee regarding the suitability of its products for any particular purpose, nor does Motorola assume any liability arising out of the application or use of any product or circuit, and specifically disclaims any and all liability, including without limitation consequential or incidental damages. "Typical" parameters which may be provided in Motorola data sheets and/or specifications can and do vary in different applications and actual performance may vary over time. All operating parameters, including "Typicals" must be validated for each customer application by customer's technical experts. Motorola does not convey any license under its patent rights nor the rights of others. Motorola products are not designed, intended, or authorized for use as components in systems intended for surgical implant into the body, or other applications intended to support or sustain life, or for any other application in which the failure of the Motorola product could create a situation where personal injury or death may occur. Should Buyer purchase or use Motorola products for any such unintended or unauthorized application, Buyer shall indemnify and hold Motorola and its officers, employees, subsidiaries, affiliates, and distributors harmless against all claims, costs, damages, and expenses, and reasonable attorney fees arising out of, directly or indirectly, any claim of personal injury or death associated with such unintended or unauthorized use, even if such claim alleges that Motorola was negligent regarding the design or manufacture of the part. Motorola and  are registered trademarks of Motorola, Inc. Motorola, Inc. is an Equal Opportunity/Affirmative Action Employer.

**How to reach us:**

**USA/EUROPE/Locations Not Listed:** Motorola Literature Distribution; P.O. Box 5405, Denver, Colorado 80217. 1-303-675-2140 or 1-800-441-2447

**JAPAN:** Motorola Japan Ltd.; SPS, Technical Information Center, 3-20-1, Minami-Azabu. Minato-ku, Tokyo 106-8573 Japan. 81-3-3440-3569

**ASIA/PACIFIC:** Motorola Semiconductors H.K. Ltd.; Silicon Harbour Centre, 2 Dai King Street, Tai Po Industrial Estate, Tai Po, N.T., Hong Kong. 852-26668334

**Technical Information Center: 1-800-521-6274**

**HOME PAGE:** <http://www.motorola.com/semiconductors/>

